

Instruction of LCDP28 Wall fixed installation

1.Product Features

LCDP28Product weight:24kg; TV size support:32-80"; Maximum load:50kg;
For VESA standard: 400x400mm 600x400 800x600mm









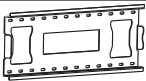

2.Hardware List

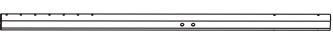











Important: We are not responsible for any personal injury or product damage due to mishandling, incorrect mounting, incorrect assembly or incorrect use of this product.

Note: The supplied wall mounting hardware is not for use on steel stud walls or cold cinder block walls. If you are uncertain what material your wall is constructed of or any question regarding the proper installation of this wall mount, contact a qualified contractor. If the hardware required is not including, please contact your local hardware store.

Caution: This LCD/Plasma wall mount is intended for use with television that does not exceed the maximum weight capacity designated. Using this mount with products heavier than the maximum weight indicated may result in instability causing possible injury.

Screw spare parts list

No.	Description	Specifications Model	Qty.
1		Panel 1	x1
2		Arm	x2
3		Bar	x1
4		Left pedestal 1	x1
5		Right pedestal 1	x1
6		pedestal	x2
7		DVD tray	x2
8		Sheet iron	x2
9		pedestal 2	x2
10		Wheel 2	x2
11		Wheel 1	x2
12		Sheet iron	x4

A		M8x60mm Cross round screw	x4
B		Plastic cover 1	x8
C		Plastic cover 2	x6
D		Φ8plastic spacer	x4
E		M8x40mm Cross round screw	x4
F		Washer	x4
G		M6 Nut	x4
H		Φ6 washer	x8
I		M6x20mm Six screws	x8
J		M5 Allen Key	x1
K		M5x8mm flat head screw	x8
L		M6x90mm Cross round screw	x4

Instruction of installation operation

1

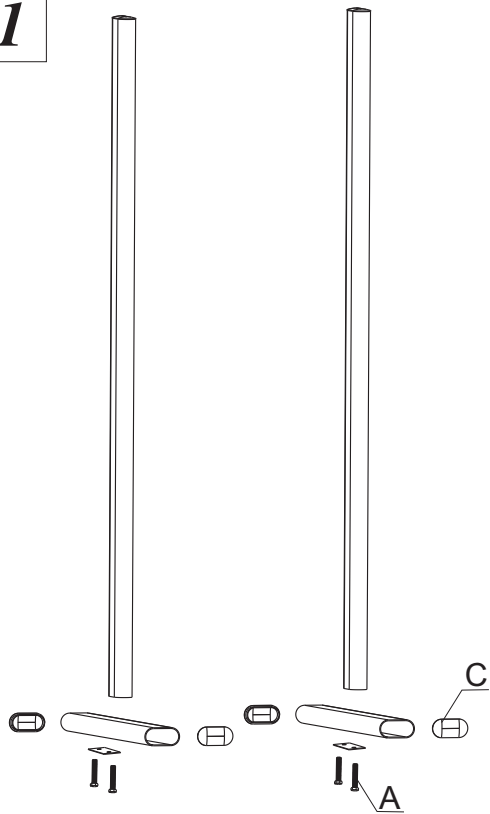

2

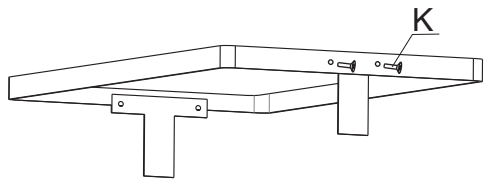

3

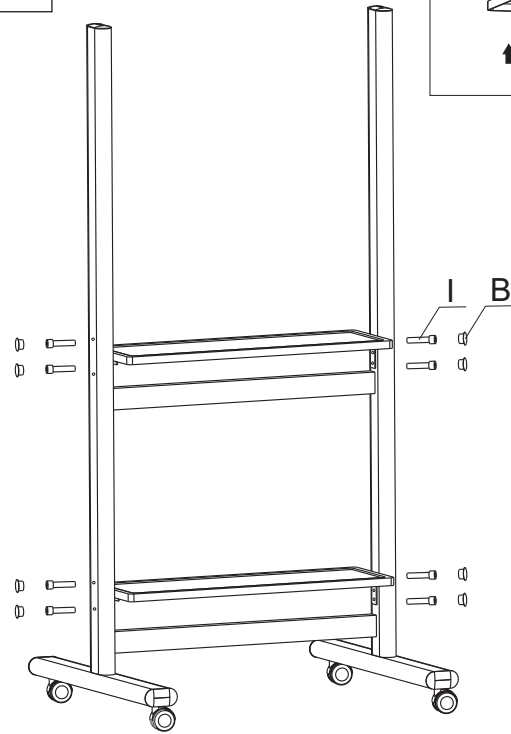

4

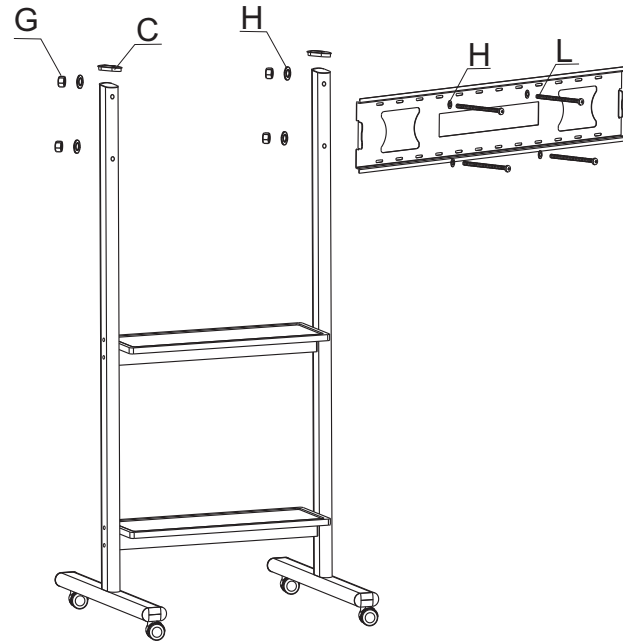

5

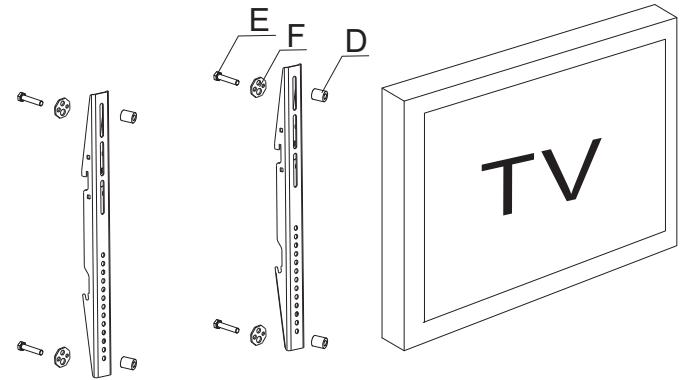

6

